

LM3202

650mA Miniature, Adjustable, Step-Down DC-DC Converter for RF Power Amplifiers

General Description

The LM3202 is a DC-DC converter optimized for powering RF power amplifiers (PAs) from a single Lithium-Ion cell, however they may be used in many other applications. It steps down an input voltage from 2.7V to 5.5V to a variable output voltage from 1.3V to 3.16V. Output voltage is set using a V_{CON} analog input for controlling power levels and efficiency of the RF PA.

The LM3202 offers superior performance for mobile phones and similar RF PA applications. Fixed-frequency PWM operation minimizes RF interference. Shutdown function turns the device off and reduces battery consumption to 0.01 μ A (typ.).

The LM3202 is available in a 8-pin lead free micro SMD package. A high switching frequency (2 MHz) allows use of tiny surface-mount components. Only three small external surface-mount components, an inductor and two ceramic capacitors are required.

Features

- 2 MHz (typ.) PWM Switching Frequency
- Operates from a single Li-Ion cell (2.7V to 5.5V)
- Variable Output Voltage (1.3V to 3.16V)
- Fast Output Voltage Transient (1.3V to 3.16V in 20 μ s)
- 650mA Maximum load capability
- High Efficiency (96% Typ at 3.6V_{IN}, 3.16V_{OUT} at 400mA) from internal synchronous rectification
- 8-pin micro SMD Package
- Current Overload Protection
- Thermal Overload Protection
- Soft Start function

Applications

- Cellular Phones
- Hand-Held Radios
- RF PC Cards
- Battery Powered RF Devices

Typical Application

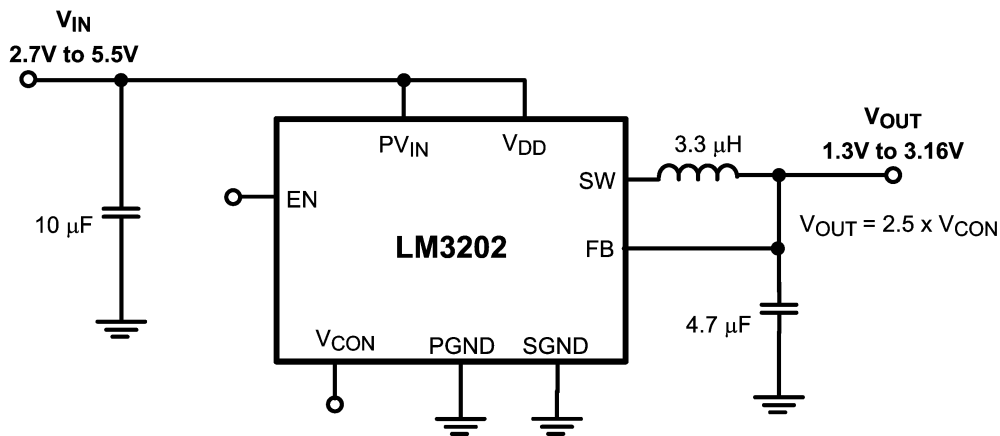

20141501

FIGURE 1. LM3202 Typical Application

Connection Diagrams

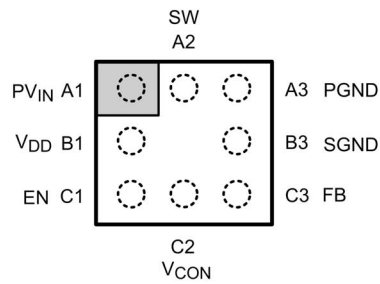

Top View

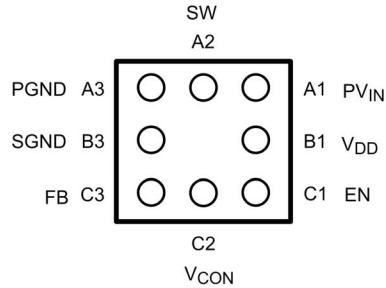

Bottom View

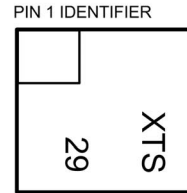

Package Mark – Top View

20141599

8-Bump Thin Micro SMD Package, Large Bump NS Package Number TLA08GNA

Order Information

Order Number	Package Marking (Note)	Supplied As
LM3202TL	XTS/29	250 units, Tape-and-Reel
LM3202TLX	XTS/29	3000 units, Tape-and-Reel

Note: The actual physical placement of the package marking will vary from part to part. The package marking "X" designates the date code. "T" is a NSC internal code for die traceability. "S" designates the device type as switcher device. Both will vary considerably. "29" identifies the device (part number, option, etc.).

Pin Descriptions

Pin #	Name	Description
A1	PV _{IN}	Power Supply Voltage Input to the internal PFET switch.
B1	V _{DD}	Analog Supply Input.
C1	EN	Enable Input. Set this digital input high for normal operation. For shutdown, set low.
C2	V _{CON}	Voltage Control Analog input. V _{CON} controls V _{OUT} in PWM mode.
C3	FB	Feedback Analog Input. Connect to the output at the output filter capacitor.
B3	SGND	Analog and Control Ground
A3	PGND	Power Ground
A2	SW	Switch node connection to the internal PFET switch and NFET synchronous rectifier. Connect to an inductor with a saturation current rating that exceeds the maximum Switch Peak Current Limit specification of the LM3202.

Absolute Maximum Ratings (Notes 1, 2)

If Military/Aerospace specified devices are required, please contact the National Semiconductor Sales Office/Distributors for availability and specifications.

V_{DD} , PV_{IN} to SGND	-0.2V to +6.0V
PGND to SGND	-0.2V to +0.2V
EN, FB, V_{CON}	(SGND -0.2V) to (V_{DD} +0.2V) w/6.0V max
SW	(PGND -0.2V) to (PV_{IN} +0.2V) w/6.0V max
PV_{IN} to V_{DD}	-0.2V to +0.2V
Continuous Power Dissipation (Note 3)	Internally Limited
Junction Temperature (T_{J-MAX})	+150°C
Storage Temperature Range	-65°C to +150°C
Maximum Lead Temperature (Soldering, 10 sec)	+260°C

ESD Rating (Notes 4, 13)

Human Body Model:	2 kV
Machine Model:	200V

Operating Ratings (Notes 1, 2)

Input Voltage Range	2.7V to 5.5V
Recommended Load Current	0mA to 650mA
Junction Temperature (T_J) Range	-30°C to +125°C
Ambient Temperature (T_A) Range (Note 5)	-30°C to +85°C

Thermal Properties

Junction-to-Ambient Thermal Resistance (θ_{JA}), TLA08 Package (Note 6)	100°C/W
----------------------------------------------------------------------------------------	---------

Electrical Characteristics (Notes 2, 7, 8) Limits in standard typeface are for $T_A = T_J = 25^\circ\text{C}$. Limits in **bold-face** type apply over the full operating ambient temperature range ($-30^\circ\text{C} \leq T_A = T_J \leq +85^\circ\text{C}$). Unless otherwise noted, all specifications apply to LM3202 with: $PV_{IN} = V_{DD} = EN = 3.6\text{V}$.

Symbol	Parameter	Conditions	Min	Typ	Max	Units
$V_{FB, MIN}$	Feedback Voltage at minimum setting	$V_{CON} = 0.4\text{V}$ (Note 8)	1.21	1.30	1.39	V
V_{FB}	Feedback Voltage	$V_{CON} = 1.1\text{V}$ (Note 8)	2.693	2.75	2.835	V
$V_{FB, MAX}$	Feedback Voltage at maximum setting	$V_{CON} = 1.4\text{V}$ (Note 8)	3.03	3.17	3.29	V
I_{SHDN}	Shutdown supply current	EN = SW = $V_{CON} = 0\text{V}$, (Note 9)		0.01	2	μA
I_Q	DC bias current into V_{DD}	$V_{CON} = 1\text{V}$, FB = 0V, No Switching (Note 10)		1	1.4	mA
$R_{DSON(P)}$	Pin-pin resistance for PFET	$I_{SW} = 200\text{mA}$		140	200 230	m Ω
$R_{DSON(N)}$	Pin-pin resistance for NFET	$I_{SW} = -200\text{mA}$		300	415 485	m Ω
$I_{LIM, PFET}$	Switch peak current limit	(Note 11)	935	1100	1200	mA
F_{OSC}	Internal oscillator frequency		1.7	2	2.3	MHz
$V_{IH, EN}$	Logic high input threshold		1.2			V
$V_{IL, EN}$	Logic low input threshold				0.5	V
$I_{PIN, ENABLE}$	Pin pull down current			5	10	μA
$V_{CON, MIN}$	V_{CON} Threshold Commanding $V_{FB, MIN}$	V_{CON} swept down(Note 8)	0.484	0.52	0.556	V
$V_{CON, MAX}$	V_{CON} Threshold Commanding $V_{FB, MAX}$	V_{CON} swept up(Note 8)	1.208	1.27	1.312	V
Z_{CON}	V_{CON} input resistance		100			k Ω
Gain	V_{CON} to V_{OUT} Gain	$0.556\text{V} \leq V_{CON} \leq 1.208\text{V}$		2.5		V/V

System Characteristics The following spec table entries are guaranteed by design providing the component values in the typical application circuit are used. **These parameters are not guaranteed by production testing.** Min and Max limits apply over the full operating ambient temperature range ($-30^{\circ}\text{C} \leq T_A \leq 85^{\circ}\text{C}$) and over the V_{IN} range = 2.7V to 5.5V unless otherwise specified, Typical values are at $T_A = 25^{\circ}\text{C}$, $PV_{\text{IN}} = V_{\text{DD}} = \text{EN} = 3.6\text{V}$ unless otherwise specified, $L = 3.3\mu\text{H}$, DCR of $L \leq 100\text{m}\Omega$, $C_{\text{IN}} = 10\mu\text{F}$, 0603, 6.3V (4.7 μF ||4.7 μF , 0603, 6.3V can also be used), $C_{\text{OUT}} = 4.7\mu\text{F}$, 0603, 6.3V

Symbol	Parameter	Conditions	Min	Typ	Max	Units
T_{RESPONSE}	Time for V_{OUT} to rise from 1.3V to 3.16V	$V_{\text{IN}} = 4.2\text{V}$, $C_{\text{OUT}} = 4.7\mu\text{F}$, $L = 3.3\mu\text{H}$, $R_{\text{LOAD}} = 5\Omega$		20	30	μs
	Time for V_{OUT} to fall from 3.16V to 1.3V	$V_{\text{IN}} = 4.2\text{V}$, $C_{\text{OUT}} = 4.7\mu\text{F}$, $L = 3.3\mu\text{H}$, $R_{\text{LOAD}} = 10\Omega$		20	30	
C_{CON}	V_{CON} input capacitance	$V_{\text{CON}} = 1\text{V}$, Test frequency = 100 kHz			20	pF
Linearity	Linearity in control range 0.556V to 1.208V	$V_{\text{IN}} = 3.6\text{V}$ Monotonic in nature	-3		+3	%
I_{CON}	Control pin input current		-10		10	μA
T_{ON}	Turn on time (time for output to reach 3.16V from Enable low to high transition)	EN = Low to High, $V_{\text{IN}} = 4.2\text{V}$, $V_{\text{O}} = 3.16\text{V}$, $C_{\text{OUT}} = 4.7\mu\text{F}$, $I_{\text{OUT}} \leq 1\text{mA}$		210	750	μs
η	Efficiency (L = 3.3 μH , DCR $\leq 100\text{m}\Omega$)	$V_{\text{IN}} = 3.6\text{V}$, $V_{\text{OUT}} = 1.3\text{V}$, $I_{\text{OUT}} = 90\text{mA}$		87		%
		$V_{\text{IN}} = 3.6\text{V}$, $V_{\text{OUT}} = 3.16\text{V}$, $I_{\text{OUT}} = 400\text{mA}$		96		%
$V_{\text{OUT_ripple}}$	Ripple voltage, PWM mode	$V_{\text{IN}} = 3\text{V}$ to 4.5V, $V_{\text{OUT}} = 1.3\text{V}$, $I_{\text{OUT}} = 10\text{mA}$ to 400mA (Note 12)		10		mVp-p
Line_tr	Line transient response	$V_{\text{IN}} = 600\text{mV}$ perturbation, over Vin range 3V to 5.5V $T_{\text{RISE}} = T_{\text{FALL}} = 10\mu\text{s}$, $V_{\text{OUT}} = 1.3\text{V}$, $I_{\text{OUT}} = 100\text{mA}$		50		mVpk
Load_tr	Load transient response	$V_{\text{IN}} = 3.1/3.6/4.5\text{V}$, $V_{\text{OUT}} = 1.3\text{V}$, transients up to 100mA, $T_{\text{RISE}} = T_{\text{FALL}} = 10\mu\text{s}$		50		mVpk
PSRR	$V_{\text{IN}} = 3.6\text{V}$, $V_{\text{OUT}} = 1.3\text{V}$, $I_{\text{OUT}} = 100\text{mA}$	sine wave perturbation frequency = 10kHz, amplitude = 100mVp-p		40		dB

Note 1: Absolute Maximum Ratings indicate limits beyond which damage to the component may occur. Operating Ratings are conditions under which operation of the device is guaranteed. Operating Ratings do not imply guaranteed performance limits. For guaranteed performance limits and associated test conditions, see the Electrical Characteristics tables.

Note 2: All voltages are with respect to the potential at the GND pins. The LM3202 is designed for mobile phone applications where turn-on after power-up is controlled by the system controller and where requirements for a small package size overrule increased die size for internal Under Voltage Lock-Out (UVLO) circuitry. Thus, it should be kept in shutdown by holding the EN pin low until the input voltage exceeds 2.7V.

Note 3: Internal thermal shutdown circuitry protects the device from permanent damage. Thermal shutdown engages at $T_J = 150^{\circ}\text{C}$ (typ.) and disengages at $T_J = 130^{\circ}\text{C}$ (typ.).

Note 4: The Human body model is a 100pF capacitor discharged through a 1.5k Ω resistor into each pin. (MIL-STD-883 3015.7) The machine model is a 200pF capacitor discharged directly into each pin.

Note 5: In applications where high power dissipation and/or poor package thermal resistance is present, the maximum ambient temperature may have to be de-rated. Maximum ambient temperature ($T_{\text{A-MAX}}$) is dependent on the maximum operating junction temperature ($T_{\text{J-MAX-OP}} = 125^{\circ}\text{C}$), the maximum power dissipation of the device in the application ($P_{\text{D-MAX}}$), and the junction-to ambient thermal resistance of the part/package in the application (θ_{JA}), as given by the following equation: $T_{\text{A-MAX}} = T_{\text{J-MAX-OP}} - (\theta_{\text{JA}} \times P_{\text{D-MAX}})$.

Note 6: Junction-to-ambient thermal resistance (θ_{JA}) is taken from thermal measurements, performed under the conditions and guidelines set forth in the JEDEC standard JESD51-7. A 4 layer, 4" x 4", 2/1/1/2 oz. Cu board as per JEDEC standards is used for the measurements.

Note 7: Min and Max limits are guaranteed by design, test, or statistical analysis. Typical numbers are not guaranteed, but do represent the most likely norm. Due to the pulsed nature of the testing $T_A = T_J$ for the electrical characteristics table.

Note 8: The parameters in the electrical characteristics table are tested under open loop conditions at $PV_{\text{IN}} = V_{\text{DD}} = 3.6\text{V}$. For performance over the input voltage range and closed loop results refer to the datasheet curves.

Note 9: Shutdown current includes leakage current of PFET.

Note 10: I_Q specified here is when the part is operating at 100% duty cycle.

Note 11: Current limit is built-in, fixed, and not adjustable. Refer to datasheet curves for closed loop data and its variation with regards to supply voltage and temperature. Electrical Characteristic table reflects open loop data (FB = 0V and current drawn from SW pin ramped up until cycle by cycle limit is activated). Closed loop current limit is the peak inductor current measured in the application circuit by increasing output current until output voltage drops by 10%.

Note 12: Ripple voltage should be measured at C_{OUT} electrode on good layout PC board and under condition using suggested inductors and capacitors.

Note 13: National Semiconductor recommends that all integrated circuits be handled with appropriate precautions. Failure to observe proper ESD handling techniques can result in damage.

Typical Performance Characteristics (Circuit in *Figure 3*, $V_{IN} = V_{DD} = EN = 3.6V$, $L = 3.3\mu H$, DCR of $L \leq 100m\Omega$, $C_{IN} = 10\mu F$, 0603, 6.3V (4.7uF/14.7uF, 0603, 6.3V can be used), $C_{OUT} = 4.7\mu F$, 0603, 6.3V unless otherwise noted)

Quiescent Current vs Supply Voltage
($V_{CON} = 2V$, $FB = 0V$, No Switching)

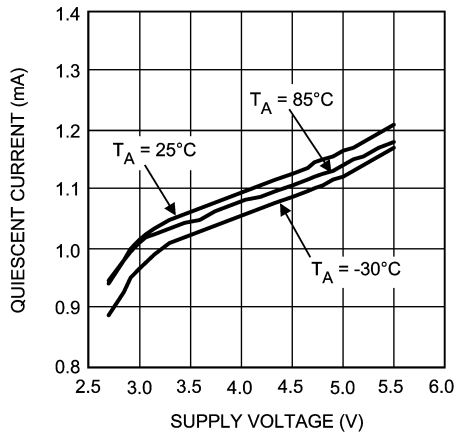

20141557

Shutdown Current vs Temperature
($V_{CON} = 0V$, $EN = 0V$)

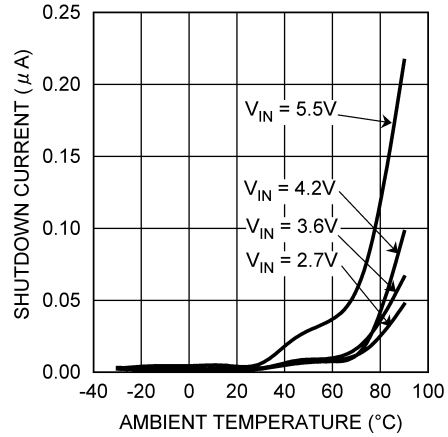

20141556

Switching Frequency Variation vs Temperature
($V_{OUT} = 1.3V$, $I_{OUT} = 200mA$)

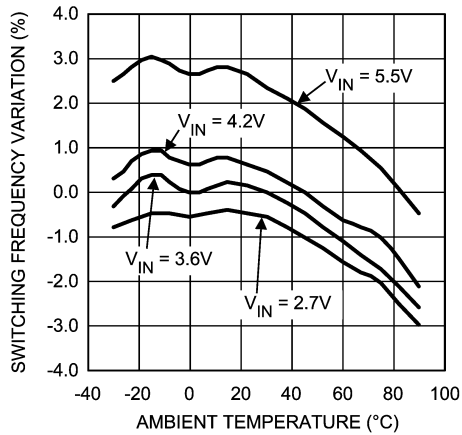

20141555

Output Voltage vs Supply Voltage
($V_{OUT} = 1.3V$: low clamp)

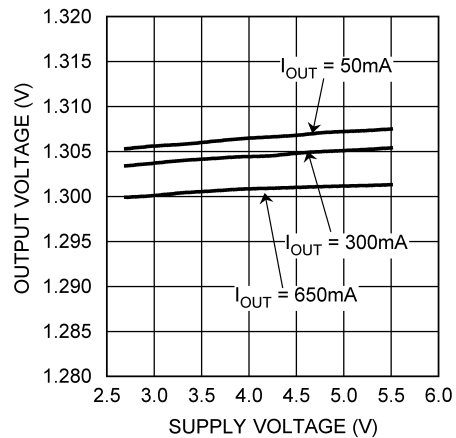

20141558

Output Voltage vs Temperature
($V_{IN} = 3.6V$, $V_{OUT} = 1.3V$: low clamp)

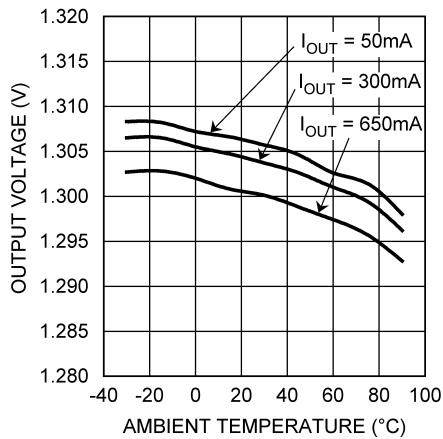

20141559

Output Voltage vs Temperature
($V_{IN} = 3.6V$, $V_{OUT} = 3.16V$: high clamp)

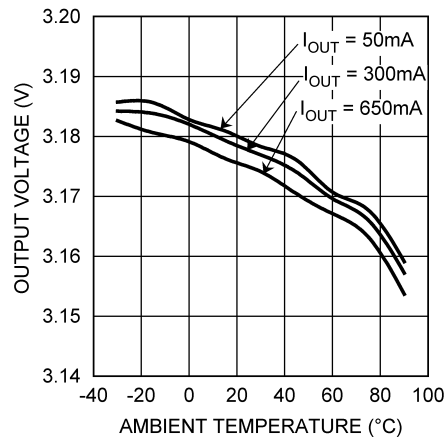

20141510

Typical Performance Characteristics (Circuit in *Figure 3*, $PV_{IN} = V_{DD} = EN = 3.6V$, $L = 3.3\mu H$, DCR of $L \leq 100m\Omega$, $C_{IN} = 10\mu F$, 0603, 6.3V (4.7uF/4.7uF, 0603, 6.3V can be used), $C_{OUT} = 4.7\mu F$, 0603, 6.3V unless otherwise noted) (Continued)

Open/Closed Loop Current Limit vs Temperature (PWM mode)

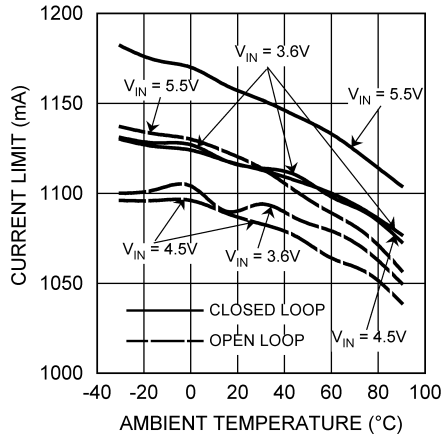

20141561

V_{CON} Voltage vs Output Voltage ($V_{IN} = 4.2V$, $R_{LOAD} = 8\Omega$)

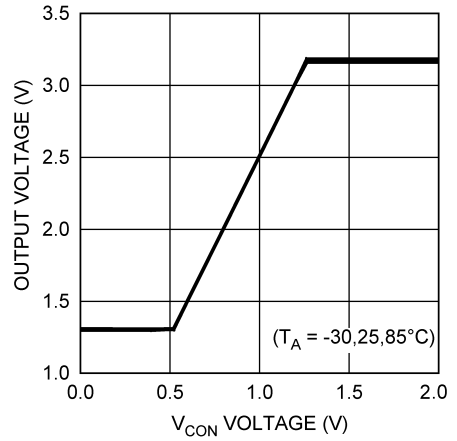

20141562

Efficiency vs Output Voltage ($V_{IN} = 3.6V$)

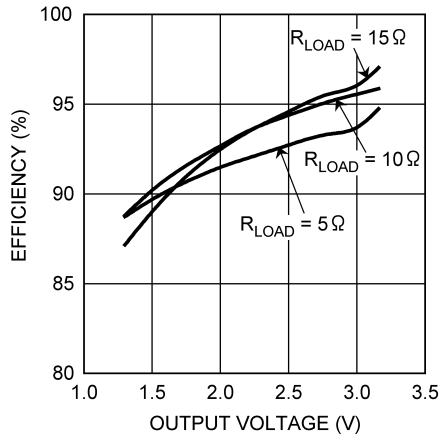

20141563

Efficiency vs Output Current ($V_{OUT} = 1.3V$)

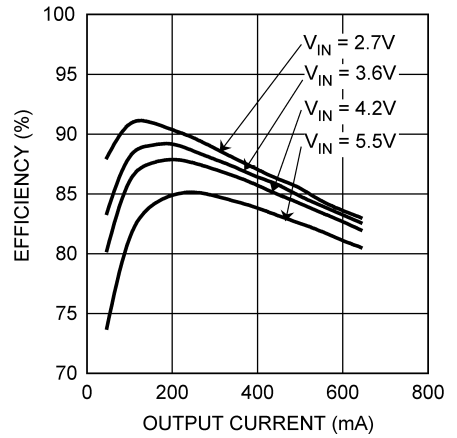

20141564

Efficiency vs Output Current ($V_{OUT} = 3.16V$)

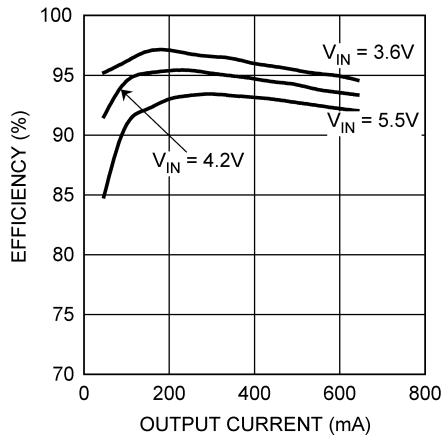

20141565

Typical Performance Characteristics (Circuit in *Figure 3*, $PV_{IN} = V_{DD} = EN = 3.6V$, $L = 3.3\mu H$, DCR of $L \leq 100m\Omega$, $C_{IN} = 10\mu F$, 0603, 6.3V (4.7uF||4.7uF, 0603, 6.3V can be used), $C_{OUT} = 4.7\mu F$, 0603, 6.3V unless otherwise noted) (Continued)

Load Transient Response
($V_{OUT} = 1.3V$)

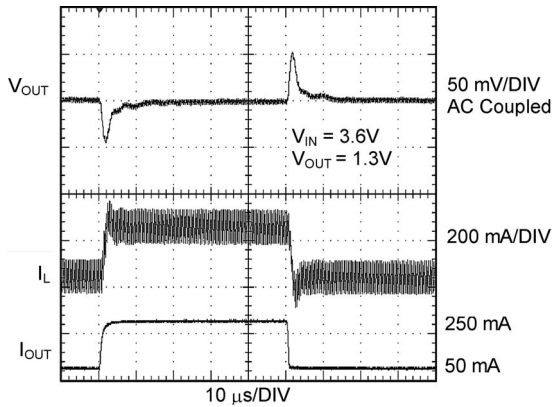

20141516

Load Transient Response
($V_{OUT} = 3.16V$)

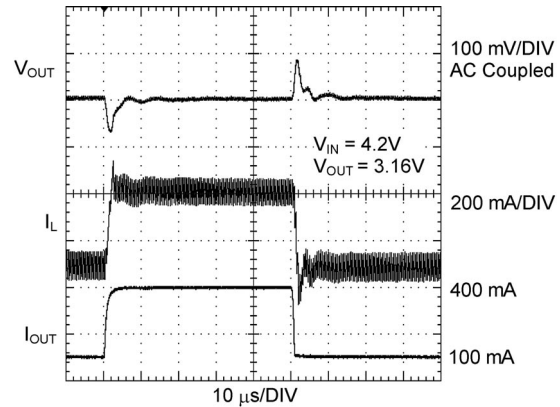

20141517

Startup
($V_{IN} = 3.6V$, $V_{OUT} = 1.3V$, $I_{OUT} < 1mA$)

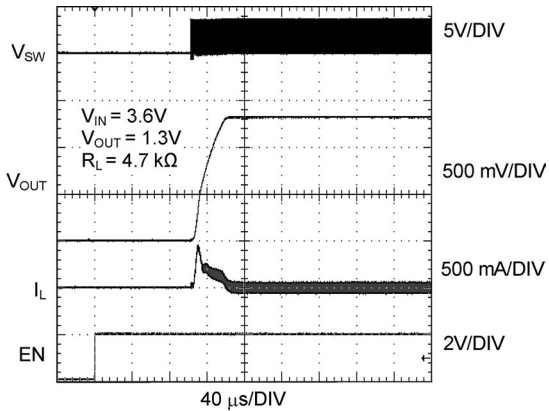

20141518

Startup
($V_{IN} = 4.2V$, $V_{OUT} = 3.16V$, $I_{OUT} < 1mA$)

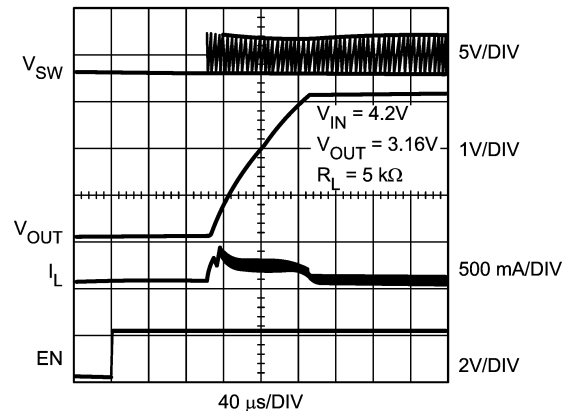

20141581

Shutdown Response
($V_{IN} = 4.2V$, $V_{OUT} = 3.16V$, $R_{LOAD} = 10\Omega$)

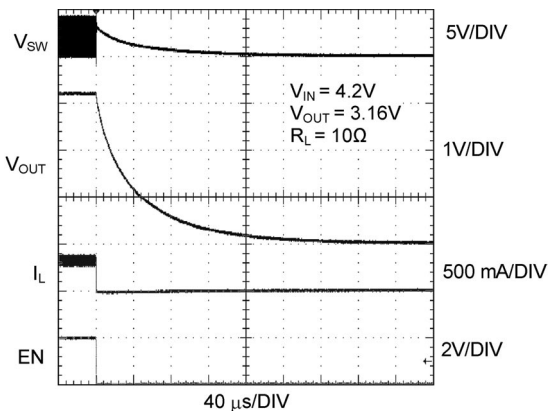

20141519

Line Transient Response
($V_{IN} = 3.0V$ to $3.6V$, $I_{OUT} = 100mA$)

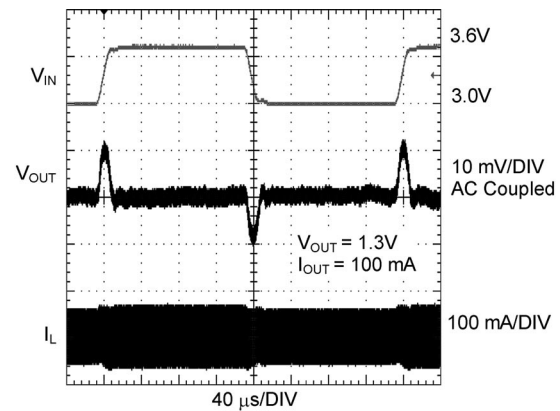

20141520

Typical Performance Characteristics (Circuit in *Figure 3*, $PV_{IN} = V_{DD} = EN = 3.6V$, $L = 3.3\mu H$, DCR of $L \leq 100m\Omega$, $C_{IN} = 10\mu F$, 0603, 6.3V (4.7uF/4.7uF, 0603, 6.3V can be used), $C_{OUT} = 4.7\mu F$, 0603, 6.3V unless otherwise noted) (Continued)

V_{CON} Voltage Response
($V_{IN} = 4.2V$, $V_{CON} = 0V/1.4V$, $R_{LOAD} = 10\Omega$)

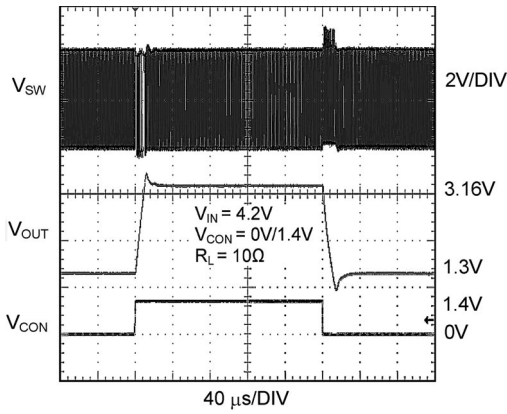

20141521

V_{CON} and Load Transient
($V_{IN} = 4.2V$, $V_{CON} = 0V/1.4V$, $15\Omega/8\Omega$, same time)

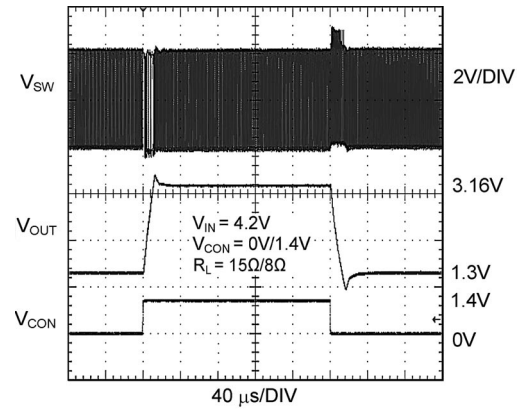

20141522

Timed Current Limit Response
($V_{IN} = 3.6V$)

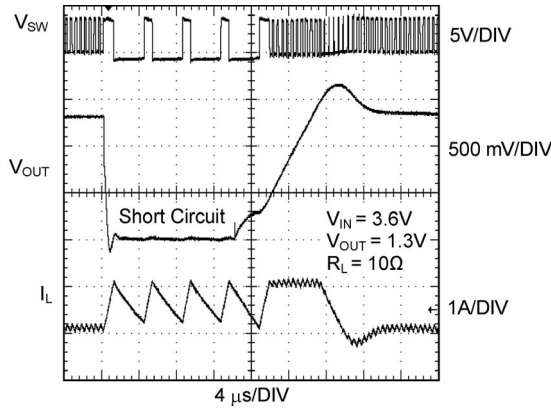

20141523

Output Voltage Ripple
($V_{OUT} = 1.3V$)

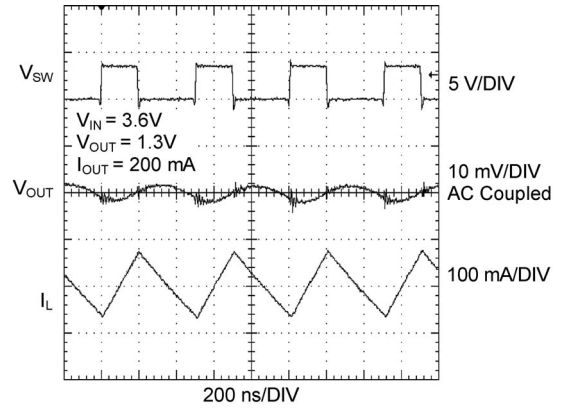

20141524

Output Voltage Ripple in Pulse Skip
($V_{IN} = 3.547V$, $V_{OUT} = 3.16V$, $R_{LOAD} = 5\Omega$)

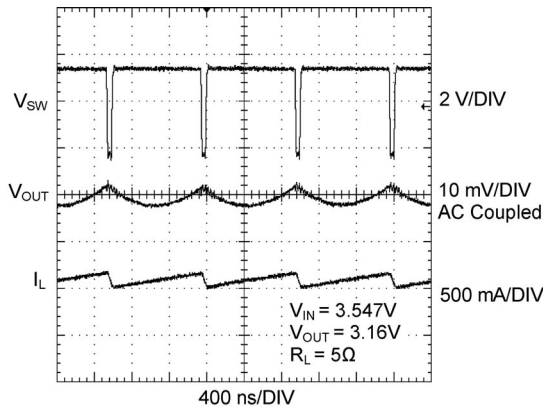

20141525

R_{DSON} vs Temperature
(P-ch, $I_{SW} = 200mA$)

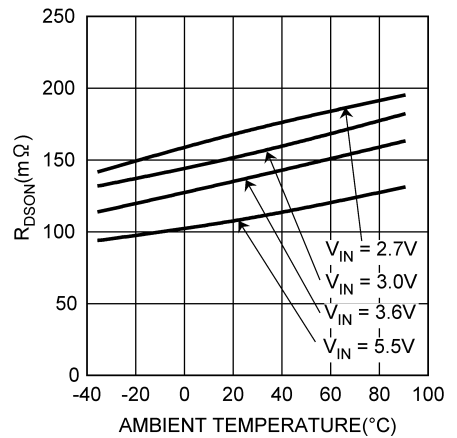

20141576

Typical Performance Characteristics (Circuit in *Figure 3*, $PV_{IN} = V_{DD} = EN = 3.6V$, $L = 3.3\mu H$, DCR of $L \leq 100m\Omega$, $C_{IN} = 10\mu F$, 0603, 6.3V (4.7uF/4.7uF, 0603, 6.3V can be used), $C_{OUT} = 4.7\mu F$, 0603, 6.3V unless otherwise noted) (Continued)

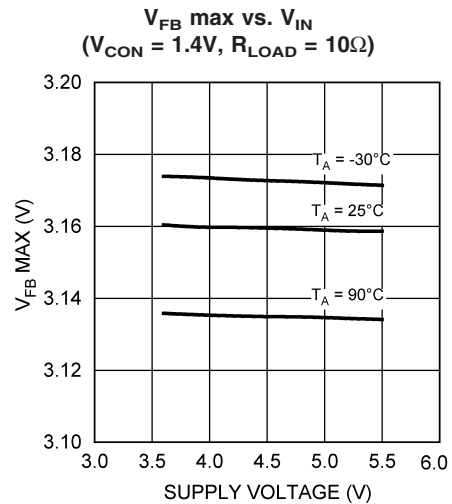
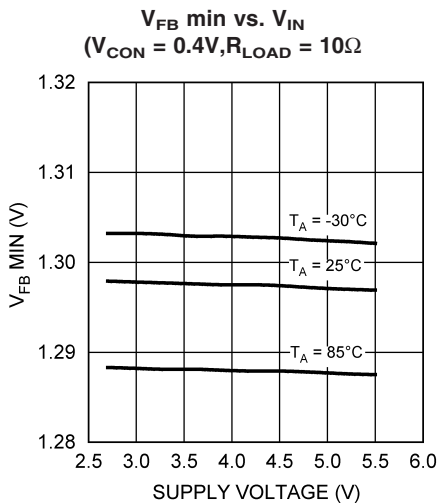
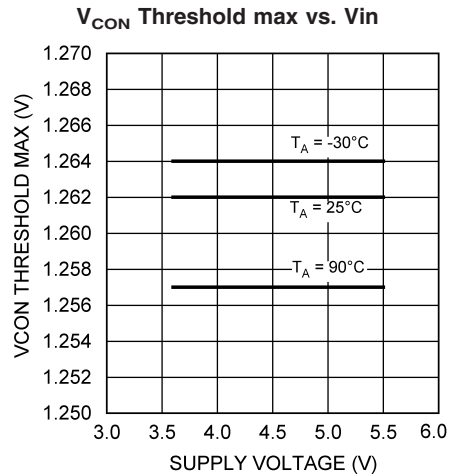
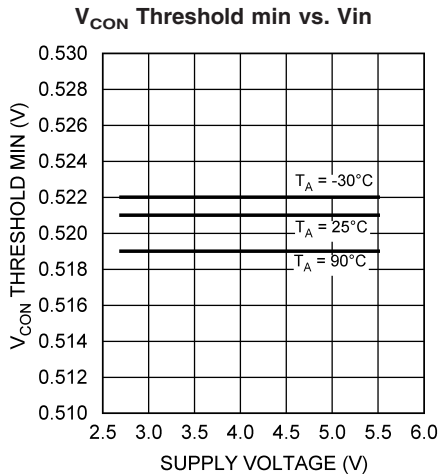
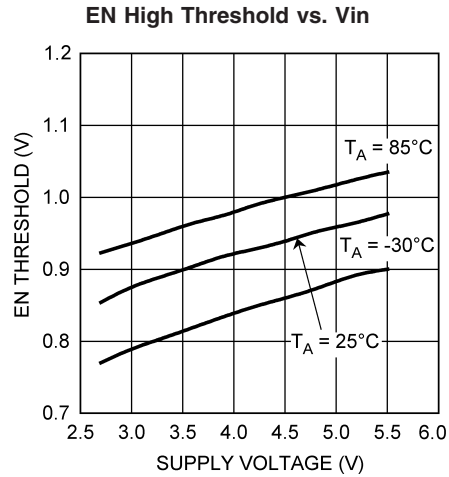
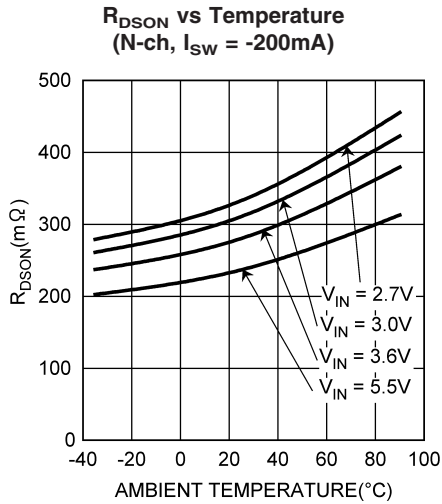

Block Diagram

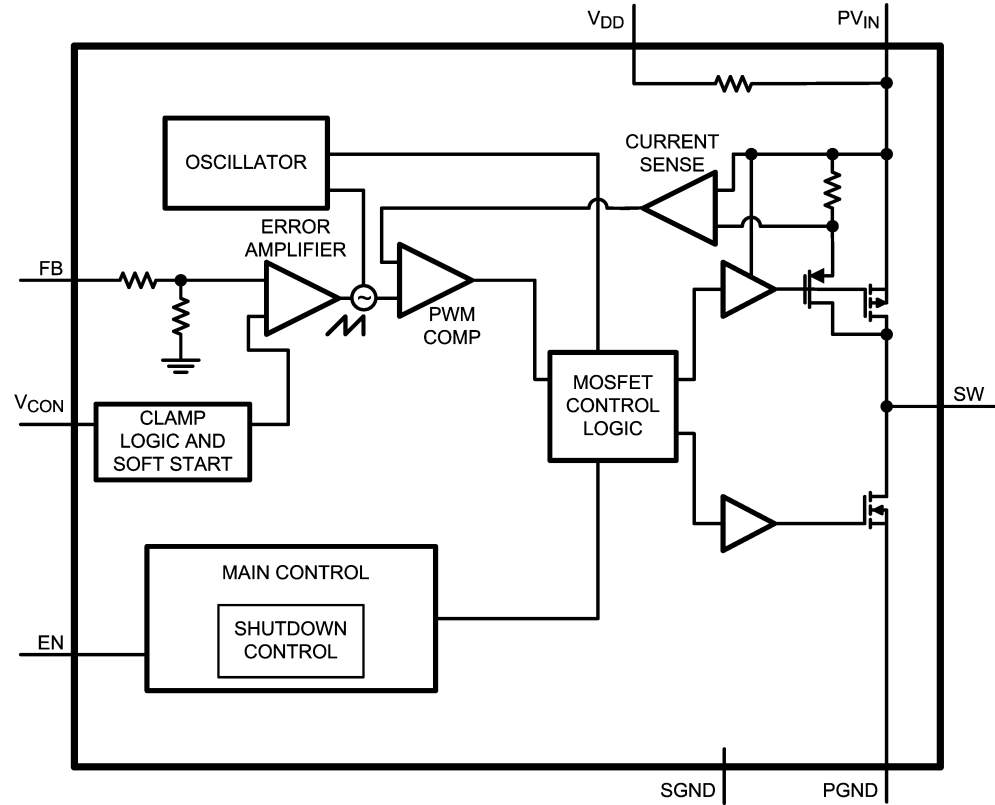

20141535

FIGURE 2. Functional Block Diagram

Operation Description

The LM3202 is a simple, step-down DC-DC converter optimized for powering RF power amplifiers (PAs) in mobile phones, portable communicators, and similar battery powered RF devices. It is designed to allow the RF PA to operate at maximum efficiency over a wide range of power levels from a single Li-Ion battery cell. It is based on a current-mode buck architecture, with synchronous rectification for high efficiency. It is designed for a maximum load capability of 650mA in PWM mode.

Maximum load range may vary from this depending on input voltage, output voltage and the inductor chosen.

Efficiency is typically around 96% for a 400mA load with 3.16V output, 3.6V input. The output voltage is dynamically programmable from 1.3V (typ) to 3.16V (typ) by adjusting the voltage on the control pin without the need for external feedback resistors. This ensures longer battery life by being able to change the PA supply voltage dynamically depending on its transmitting power.

Additional features include current overload protection, thermal overload shutdown and soft start.

The LM3202 is constructed using a chip-scale 8-pin micro SMD package. This package offers the smallest possible size, for space-critical applications such as cell phones, where board area is an important design consideration. Use of a high switching frequency (2MHz) reduces the size of external components. As shown in *Figure 1*, only three external power components are required for implementation. Use of a micro SMD package requires special design considerations for implementation. (See Micro SMD Package Assembly and use in the Applications Information section.) Its fine bump-pitch requires careful board design and precision assembly equipment. Use of this package is best suited for opaque-case applications, where its edges are not subject to high-intensity ambient red or infrared light. Also, the system controller should set EN low during power-up and other low supply voltage conditions. (See Shutdown Mode in the Device Information section.)

Operation Description (Continued)

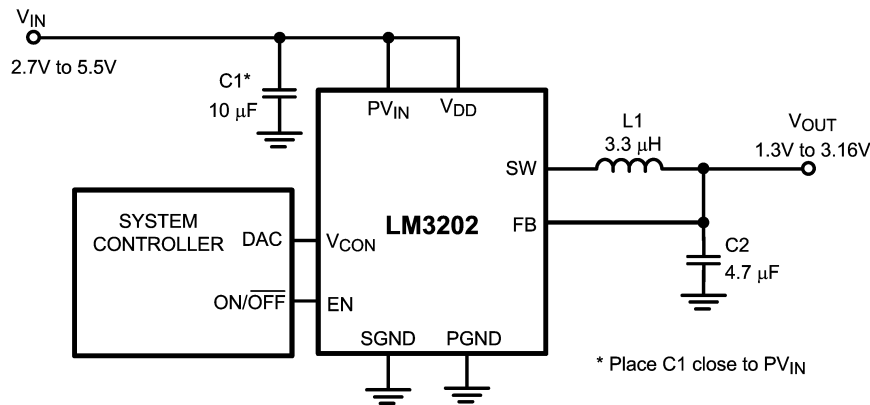

20141536

FIGURE 3. Typical Operating System Circuit

Circuit Operation

Referring to *Figure 1* and *Figure 2*, the LM3202 operates as follows. During the first part of each switching cycle, the control block in the LM3202 turns on the internal PFET (P-channel MOSFET) switch. This allows current to flow from the input through the inductor to the output filter capacitor and load. The inductor limits the current to a ramp with a slope of around $(V_{IN} - V_{OUT}) / L$, by storing energy in a magnetic field. During the second part of each cycle, the controller turns the PFET switch off, blocking current flow from the input, and then turns the NFET (N-channel MOSFET) synchronous rectifier on. In response, the inductor's magnetic field collapses, generating a voltage that forces current from ground through the synchronous rectifier to the output filter capacitor and load. As the stored energy is transferred back into the circuit and depleted, the inductor current ramps down with a slope around V_{OUT} / L . The output filter capacitor stores charge when the inductor current is high, and releases it when low, smoothing the voltage across the load.

The output voltage is regulated by modulating the PFET switch on time to control the average current sent to the load. The effect is identical to sending a duty-cycle modulated rectangular wave formed by the switch and synchronous rectifier at SW to a low-pass filter formed by the inductor and output filter capacitor. The output voltage is equal to the average voltage at the SW pin.

While in operation, the output voltage is regulated by switching at a constant frequency and then modulating the energy per cycle to control power to the load. Energy per cycle is set by modulating the PFET switch on-time pulse width to control the peak inductor current. This is done by comparing the signal from the current-sense amplifier with a slope compensated error signal from the voltage-feedback error amplifier. At the beginning of each cycle, the clock turns on the PFET switch, causing the inductor current to ramp up. When the current sense signal ramps past the error amplifier signal, the PWM comparator turns off the PFET switch and turns on the NFET synchronous rectifier, ending the first part of the cycle. If an increase in load pulls the output down, the error amplifier output increases, which allows the inductor current

to ramp higher before the comparator turns off the PFET. This increases the average current sent to the output and adjusts for the increase in the load.

Before appearing at the PWM comparator, a slope compensation ramp from the oscillator is subtracted from the error signal for stability of the current feedback loop. The minimum on time of PFET in PWM mode is 50ns (typ.)

Shutdown Mode

Setting the EN digital pin low ($<0.5V$) places the LM3202 in a $0.01\mu A$ (typ.) Shutdown mode. During shutdown, the PFET switch, NFET synchronous rectifier, reference voltage source, control and bias circuitry of the LM3202 are turned off. Setting EN high ($>1.2V$) enables normal operation.

EN should be set low to turn off the LM3202 during power-up and under voltage conditions when the power supply is less than the 2.7V minimum operating voltage. The LM3202 is designed for compact portable applications, such as mobile phones. In such applications, the system controller determines power supply sequencing and requirements for small package size outweigh the additional size required for inclusion of UVLO (Under Voltage Lock-Out) circuitry.

Internal Synchronous Rectification

The LM3202 uses an internal NFET as a synchronous rectifier to reduce rectifier forward voltage drop and associated power loss. Synchronous rectification provides a significant improvement in efficiency whenever the output voltage is relatively low compared to the voltage drop across and ordinary rectifier diode.

The internal NFET synchronous rectifier is turned on during the inductor current down slope in the second part of each cycle. The synchronous rectifier is turned off prior to the next cycle. The NFET is designed to conduct through its intrinsic body diode during transient intervals before it turns on, eliminating the need for an external diode.

Current Limiting

A current limit feature allows the LM3202 to protect itself and external components during overload conditions. In PWM mode, an 1200mA (max.) cycle-by-cycle current limit is normally used. If an excessive load pulls the output voltage

Current Limiting (Continued)

down to approximately 0.375V, then the device switches to a timed current limit mode. In timed current limit mode the internal PFET switch is turned off after the current comparator trips and the beginning of the next cycle is inhibited for 3.5 μ s to force the instantaneous inductor current to ramp down to a safe value. The synchronous rectifier is off in timed current limit mode. Timed current limit prevents the loss of current control seen in some products when the output voltage is pulled low in serious overload conditions.

Dynamically Adjustable Output Voltage

The LM3202 features dynamically adjustable output voltage to eliminate the need for external feedback resistors. The output can be set from $V_{FB,MIN}$ to $V_{FB,MAX}$ by changing the voltage on the analog V_{CON} pin. This feature is useful in PA applications where peak power is needed only when the handset is far away from the base station or when data is being transmitted. In other instances the transmitting power can be reduced. Hence the supply voltage to the PA can be reduced, promoting longer battery life. See *Setting the Output Voltage* in the *Application Information* section for further details.

Thermal Overload Protection

The LM3202 has a thermal overload protection function that operates to protect itself from short-term misuse and overload conditions. When the junction temperature exceeds around 150°C, the device inhibits operation. Both the PFET and the NFET are turned off in PWM mode. When the temperature drops below 125°C, normal operation resumes. Prolonged operation in thermal overload conditions may damage the device and is considered bad practice.

Application Information

SETTING THE OUTPUT VOLTAGE

The LM3202 features a pin-controlled variable output voltage to eliminate the need for external feedback resistors. It can be programmed for an output voltage from 1.3V (typ) to 3.16V (typ) by setting the voltage on the V_{CON} pin, as in *Table 1*.

TABLE 1. Output Voltage Selection

$V_{CON}(V)$	$V_{OUT} (V)$
$V_{CON} \leq 0.484$	$V_{FB,MIN}$
$0.556 < V_{CON} < 1.208$	$V_{OUT} = 2.5 \times V_{CON}$
$V_{CON} \geq 1.312$	$V_{FB,MAX}$

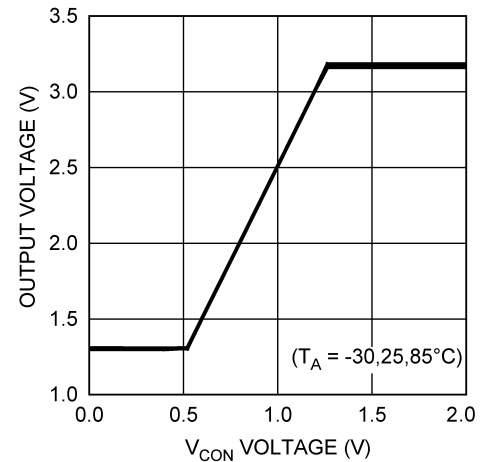

20141562

FIGURE 4. V_{CON} Voltage vs Output Voltage

Refer to *Figure 4* for the relation between V_{OUT} and V_{CON} . When the control pin voltage is between 0.556V and 1.208V, the output voltage will vary in a monotonic fashion with respect to the voltage on the control pin as per the above *Table 1* equation.

Internally the control pin is clamped before it is fed to the error amplifier inputs. If voltage on the control pin is less than 0.484V, the output voltage is regulated at $V_{FB,MIN}$ and if the voltage is greater than 1.312V, the output is regulated at $V_{FB,MAX}$.

INDUCTOR SELECTION

A 3.3 μ H inductor with saturation current rating over 1200mA is recommended for almost all applications. The inductor's resistance should be less than 0.2 Ω for good efficiency. For low dropout voltage, lower DCR inductors are advantageous. Using inductors that drop by 20% in value at 1200mA over the operating temp range is acceptable if needed to select smallest inductor. *Table 2* suggests some inductors and suppliers.

TABLE 2. Suggested inductors and their suppliers

Model	Size (WxLxH) [mm]	Vendor
NR3015T3R3M	3.0 x 3.0 x 1.5	Taiyo-Yuden
DO3314-332MXC	3.3 x 3.3x 1.4	Coilcraft

If smaller inductance inductor is used in the application, the LM3202 may become unstable during line and load transients and V_{CON} transient response times may get affected.

For low-cost applications, an unshielded bobbin inductor is suggested. For noise critical applications, a toroidal or shielded-bobbin inductor should be used. A good practice is to layout the board with footprints accommodating both types for design flexibility. This allows substitution of a low-noise toroidal inductor, in the event that noise from low-cost bobbin models is unacceptable. Saturation occurs when the magnetic flux density from current through the windings of the inductor exceeds what the inductor's core material can support with a corresponding magnetic field. This can cause poor efficiency, regulation errors or stress to DC-DC converter like the LM3202.

Application Information (Continued)

CAPACITOR SELECTION

The LM3202 is designed for ceramic capacitor for its input and output filters. Use a 10 μ F ceramic capacitor for input and a 4.7 μ F ceramic capacitor for output. Ceramic capacitors types such as X5R, X7R are recommended to use for both filters. These provide an optimal balance between small size, cost, reliability and performance for cell phones and similar applications. *Table 3* lists suggests some part numbers and suppliers. DC bias characteristics of the capacitors must be considered when selecting the voltage rating and case size of the capacitor. Smaller case sizes for the output mitigates piezo electric vibrations of the capacitor when the output voltage is stepped up and down at fast rates however they have a bigger percentage drop in value with dc bias. Use of multiple 2.2 μ F or 1 μ F capacitors can also be considered.

TABLE 3. Suggested capacitors and their suppliers

Model	Vendor
JMK212BJ475, 4.7 μ F, 6.3V	Taiyo-Yuden
GRM188R60J475, 4.7 μ F, 6.3V	MuRata
C2012X5R0J106, 10 μ F, 6.3V	TDK

The input filter capacitor supplies AC current drawn by the PFET switch of the LM3202 in the first part of each cycle and reduces the voltage ripple imposed on the input power source. The output filter capacitor absorbs the AC inductor current, helps maintain a steady output voltage during transient load changes and reduces output voltage ripple. These capacitors must be selected with sufficient capacitance and sufficiently low ESR (Equivalent Series Resistance) to perform these functions. The ESR of the filter capacitors is generally a major factor in voltage ripple.

EN PIN CONTROL

Drive the EN pin using the system controller to turn the LM3202 ON and OFF. Use a comparator, Schmidt trigger or logic gate to drive the EN pin. Set EN high (>1.2V) for normal operation and low (<0.5V) for a 0.01 μ A (typ.) shut-down mode.

Set EN low to turn off the LM3202 during power-up and under voltage conditions when the power supply is less than the 2.7V minimum operating voltage. The part is out of regulation when the input voltage is less than 2.7V. The LM3202 is designed for mobile phones where the system controller controls operation mode for maximizing battery life and requirements for small package size outweigh the additional size required for inclusion of UVLO (Under Voltage Lock-Out) circuitry.

Micro SMD PACKAGE ASSEMBLY AND USE

Use of the Micro SMD package requires specialized board layout, precision mounting and careful re-flow techniques, as detailed in National Semiconductor Application Note 1112. Refer to the section *Surface Mount Technology (SMD) Assembly Considerations*. For best results in assembly, alignment ordinals on the PC board should be used to facilitate placement of the device. The pad style used with Micro SMD package must be the NSMD (non-solder mask defined) type. This means that the solder-mask opening is larger than the pad size. This prevents a lip that otherwise forms if the solder-mask and pad overlap, from holding the device off the

surface of the board and interfering with mounting. See Application Note 1112 for specific instructions how to do this.

The 8-Bump package used for LM3202 has 300micron solder balls and requires 10.82mil pads for mounting on the circuit board. The trace to each pad should enter the pad with a 90° entry angle to prevent debris from being caught in deep corners. Initially, the trace to each pad should be 7mil wide, for a section approximately 7mil long, as a thermal relief. Then each trace should neck up or down to its optimal width. The important criterion is symmetry. This ensures the solder bumps on the LM3202 re-flow evenly and that the device solders level to the board. In particular, special attention must be paid to the pads for bumps A1, A3 and B3. Because PGND and PVIN are typically connected to large copper planes, inadequate thermal relief's can result in late or inadequate re-flow of these bumps.

The Micro SMD package is optimized for the smallest possible size in applications with red or infrared opaque cases. Because the Micro SMD package lacks the plastic encapsulation characteristic of larger devices, it is vulnerable to light. Backside metallization and/or epoxy coating, along with front-side shading by the printed circuit board, reduce this sensitivity. However, the package has exposed die edges. In particular, Micro SMD devices are sensitive to light, in the red and infrared range, shining on the package's exposed die edges.

BOARD LAYOUT CONSIDERATIONS

PC board layout is an important part of DC-DC converter design. Poor board layout can disrupt the performance of a DC-DC converter and surrounding circuitry by contributing to EMI, ground bounce, and resistive voltage loss in the traces. These can send erroneous signals to the DC-DC converter IC, resulting in poor regulation or instability. Poor layout can also result in re-flow problems leading to poor solder joints between the Micro SMD package and board pads. Poor solder joints can result in erratic or degraded performance. Good layout for the LM3202 can be implemented by following a few simple design rules.

1. Place the LM3202 on 10.82mil pads. As a thermal relief, connect to each pad with a 7mil wide, approximately 7mil long traces, and when incrementally increase each trace to its optimal width. The important criterion is symmetry to ensure the solder bumps on the LM3202 re-flow evenly (*see Micro SMD Package Assembly and Use*).
2. Place the LM3202, inductor and filter capacitors close together and make the trace short. The traces between these components carry relatively high switching currents and act as antennas. Following this rule reduces radiated noise. Place the capacitors and inductor within 0.2inch (5mm) of the LM3202.
3. Arrange the components so that the switching current loops curl in the same direction. During the first half of each cycle, current flows from the input filter capacitor, through the LM3202 and inductor to the output filter capacitor and back through ground, forming a current loop. In the second half of each cycle, current is pulled up from ground, through the LM3202 by the inductor, to the output filter capacitor and then back through ground, forming a second current loop. Routing these loops so the current curls in the same direction prevents magnetic field reversal between the two half-cycles and reduces radiated noise.

Application Information (Continued)

4. Connect the ground pins of the LM3202, and filter capacitors together using generous component-side copper fill as a pseudo-ground plane. Then connect this to the ground-plane (if one is used) with several vias. This reduces ground-plane noise by preventing the switching currents from circulating through the ground plane. It also reduces ground bounce at the LM3202 by giving it a low-impedance ground connection.
5. Use wide traces between the power components and for power connections to the DC-DC converter circuit. This reduces voltage errors caused by resistive losses across the traces
6. Route noise sensitive traces, such as the voltage feedback path, away from noisy traces between the power components. The voltage feedback trace must remain close to the LM3202 circuit and should be routed directly from FB to V_{OUT} at the output capacitor and should be routed opposite to noise components. This reduces EMI radiated onto the DC-DC converter's own voltage feedback trace.

Physical Dimensions inches (millimeters) unless otherwise noted

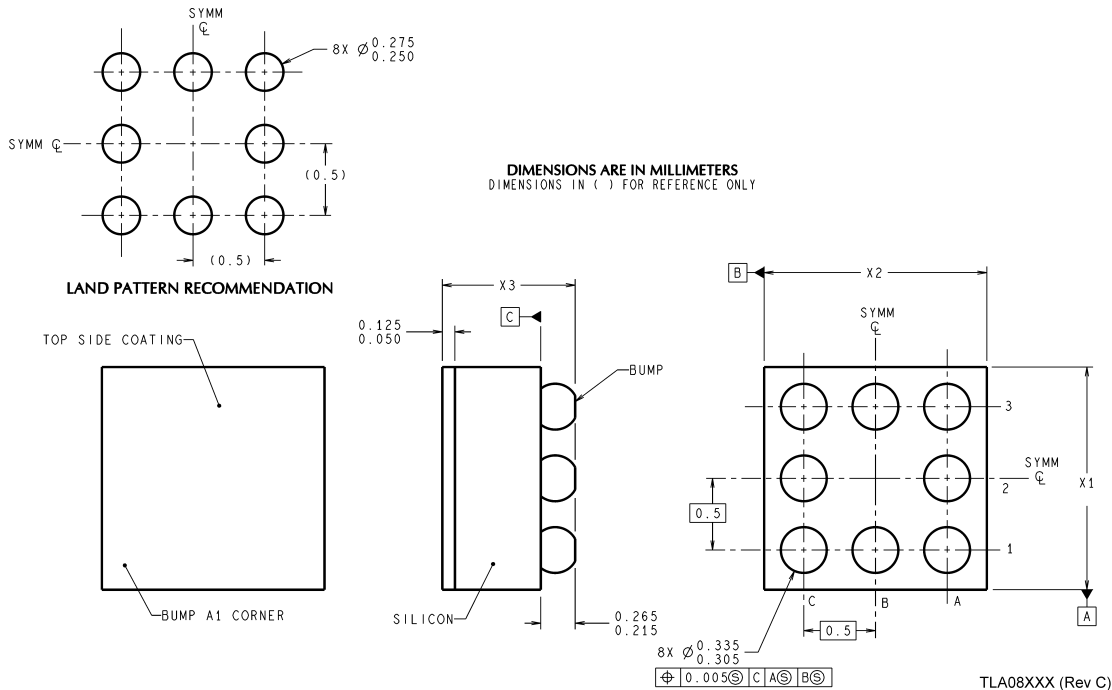

8-Bump Thin Micro SMD, Large Bump
X1 = 1.666mm ± 0.030mm
X2 = 1.819mm ± 0.030mm
X3 = 0.600mm ± 0.075mm
NS Package Number TLA08GNA

National does not assume any responsibility for use of any circuitry described, no circuit patent licenses are implied and National reserves the right at any time without notice to change said circuitry and specifications.
 For the most current product information visit us at www.national.com.

LIFE SUPPORT POLICY

NATIONAL'S PRODUCTS ARE NOT AUTHORIZED FOR USE AS CRITICAL COMPONENTS IN LIFE SUPPORT DEVICES OR SYSTEMS WITHOUT THE EXPRESS WRITTEN APPROVAL OF THE PRESIDENT AND GENERAL COUNSEL OF NATIONAL SEMICONDUCTOR CORPORATION. As used herein:

1. Life support devices or systems are devices or systems which, (a) are intended for surgical implant into the body, or (b) support or sustain life, and whose failure to perform when properly used in accordance with instructions for use provided in the labeling, can be reasonably expected to result in a significant injury to the user.
2. A critical component is any component of a life support device or system whose failure to perform can be reasonably expected to cause the failure of the life support device or system, or to affect its safety or effectiveness.

BANNED SUBSTANCE COMPLIANCE

National Semiconductor manufactures products and uses packing materials that meet the provisions of the Customer Products Stewardship Specification (CSP-9-111C2) and the Banned Substances and Materials of Interest Specification (CSP-9-111S2) and contain no "Banned Substances" as defined in CSP-9-111S2.
 Leadfree products are RoHS compliant.

National Semiconductor
Americas Customer Support Center
 Email: new.feedback@nsc.com
 Tel: 1-800-272-9959

National Semiconductor
Europe Customer Support Center
 Fax: +49 (0) 180-530 85 86
 Email: europe.support@nsc.com
 Deutsch Tel: +49 (0) 69 9508 6208
 English Tel: +44 (0) 870 24 0 2171
 Français Tel: +33 (0) 1 41 91 8790

National Semiconductor
Asia Pacific Customer Support Center
 Email: ap.support@nsc.com

National Semiconductor
Japan Customer Support Center
 Fax: 81-3-5639-7507
 Email: jpn.feedback@nsc.com
 Tel: 81-3-5639-7560